



ALUMINUM TRAIL CRASH BAR

Ref.: 2AS1970087



ASSEMBLY INSTRUCTION / INSTRUÇÃO DE MONTAGEM

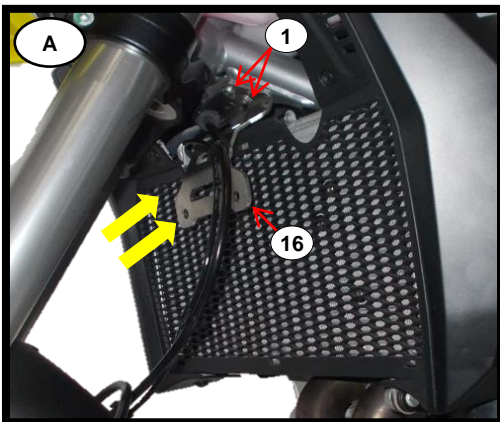

English:

- Apply item N°16 (Inox Clamp – x1) with item N°1 (Screw – x2).

Français:

- Appliquer l'item N°16 (Fixation Inox – x1) avec l'item N°1 (Vis – x2).

Português:

- Aplicar o item N°16 (Fixação Inox – x1) com o item N°1 (Parafuso – x2).

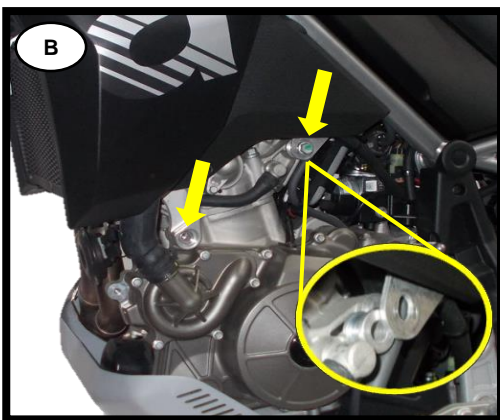

English:

- Remove original screws marked in the photo.

ATTENTION: keep the original bushing.

Français:

- Enlever les vis d'origine marquées sur la photo.

ATTENTION: conserver la douille d'origine.

Português:

- Remover parafusos de origem marcados na foto.

ATENÇÃO: manter casquilho de origem.

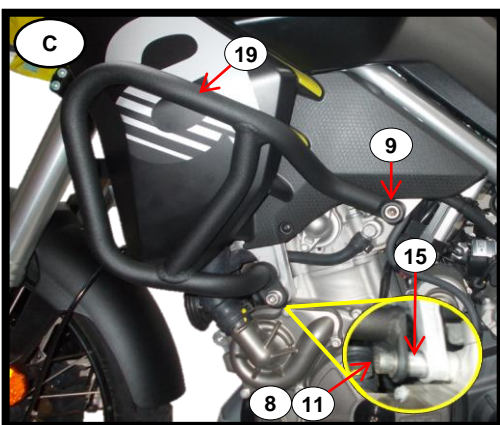

English:

- Apply item N°19 (Upper Left Crash Bar – x1) according to the photo.

Français:

- Appliquer l'item N°19 (Crash Bar Supérieur Gauche – x1) conforme à la photo.

Português:

- Aplicar o item N°19 (Carenagem Superior Esquerda – x1) conforme a foto.

21	Carenagem Superior Direita / Upper Right Crash Bar	R87	1
20	Carenagem Inferior Direita / Lower Right Crash Bar	R87	1
19	Carenagem Superior Esquerda / Upper Left Crash Bar	L87	1
18	Carenagem Inferior Esquerda / Lower Left Crash Bar	L87	1
17	Fixação Inox / Inox Clamp	N°172	1
16	Fixação Inox / Inox Clamp	N°171	1
15	Casquilho Alumínio / Aluminum Bushing	Ø20xØ11x25mm	1
14	Casquilho Alumínio / Aluminum Bushing	Ø20xØ11x15mm	1
13	Mola de Friso / Clip Inox	M6	2
12	Porca Freada / Nut Nylock	M8 - DIN 985	1
11	Anilha / Washer	M10 - DIN 125	2
10	Anilha / Washer	M8 - DIN 125	1
9	Paraf. Cabeça Cilíndrica Sext. Int. / Socket Head Cap Screw	M10x90 - DIN 912	2
8	Paraf. Cabeça Cilíndrica Sext. Int. / Socket Head Cap Screw	M10x70 - DIN 912	2
7	Paraf. Cabeça Cilíndrica Sext. Int. / Socket Head Cap Screw	M10x60 - DIN 912	1
6	Paraf. Cabeça Cilíndrica Sext. Int. / Socket Head Cap Screw	M6x16 - DIN 912	2
5	Paraf. Sext. Ext. c. FA / Hex Screw With Washer False	M8x20 - DIN 6921	2
4	Paraf. Cabeça Redonda Sext. Int. c. FA / Screw Round Head With Washer False	M8x20 - ISO 7380	1
3	Paraf. Cabeça Redonda Sext. Int. c. FA / Screw Round Head With Washer False	M6x35 - ISO 7380	1
2	Paraf. Cabeça Redonda Sext. Int. c. FA / Screw Round Head With Washer False	M6x16 - ISO 7380	2
1	Paraf. Cabeça Redonda Sext. Int. c. FA / Screw Round Head With Washer False	M6x12 - ISO 7380	2
ITEM N°:	COMPONENTE (COMPONENT):	DESCRIÇÃO (DESCRIPTION):	QUANT.:
ACESSÓRIOS (ACCESSORIES)			

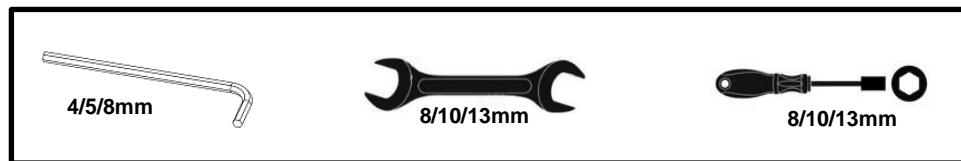

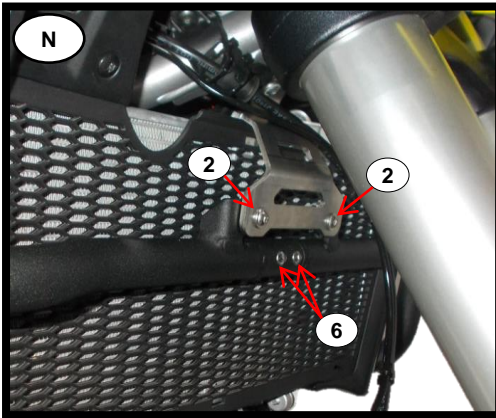

English:

- Assemble the items according to the photo.

Français:

- Assembler les items comme sur la photo.

Português:

- Montar os itens de acordo com a foto.

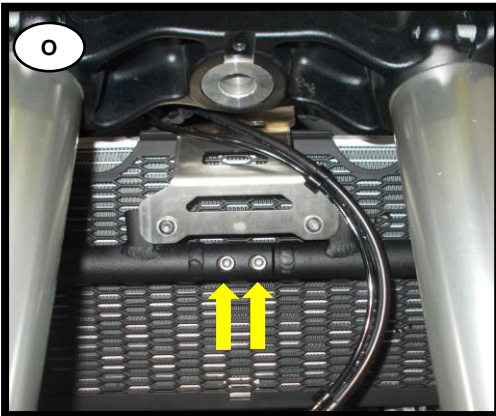

English:

- Tighten all screws, starting with union marked in the photo.

Français:

- Serrez toutes les vis en commençant par le raccord indiqué sur la photo.

Português:

- Apertar todos os parafusos, iniciando pela união marcada na foto.



English:

- Tight all screws.

Français:

- Serrer toutes les vis.

Português:

- Apertar todos os parafusos.

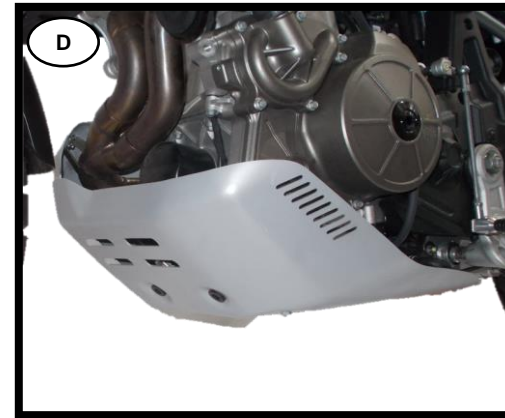

English:

- Remove origin engine protection.

Français:

- Retirer la protection du moteur d'origine.

Português:

- Remover proteção de motor de origem.

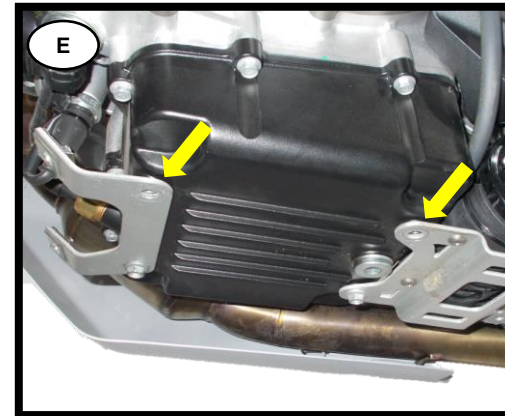

English:

- Remove original screws marked in the photo.

Français:

- Retirer les vis d'origine marquées sur la photo.

Português:

- Remover parafusos de origem marcados na foto.

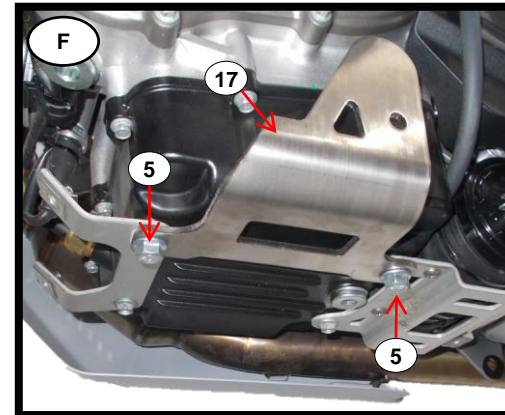

English:

- Apply item N°17 (Inox Clamp – x1) with item N°5 (Screw – x2).

Français:

- Appliquer l'item N°17 (Fixation Inox – x1) avec l'item N°5 (Vis – x2).

Português:

- Aplicar o item N°17 (Fixação Inox – x1) com o item N°5 (Parafuso – x5).

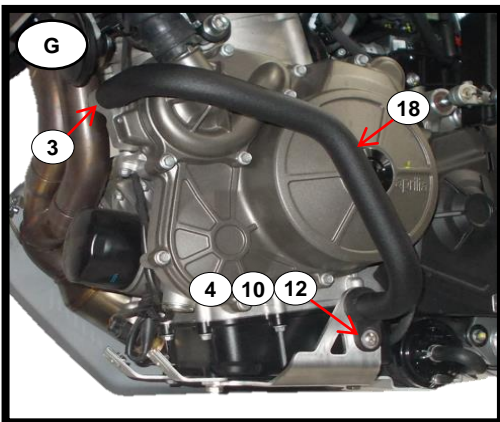

English:

- Apply item N°18 (Lower Left Crash Bar – x1) according to the photo.

Français:

- Appliquer l'item N°18 (Crash Bar Inférieur Gauche – x1) conforme à la photo.

Português:

- Aplicar o item N°18 (Carenagem Inferior Esquerda – x1) de acordo com a foto.

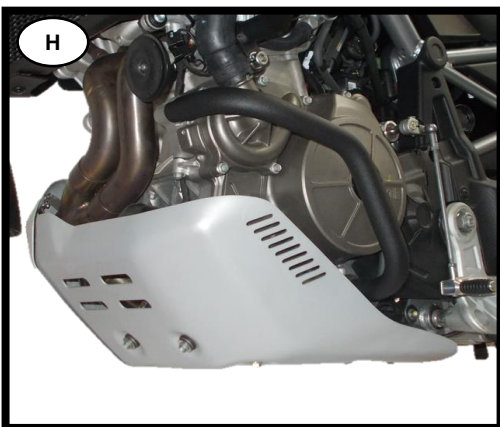

English:

- Assemble engine protection.

Français:

- Assemblez la protection moteur.

Português:

- Montar proteção de motor.

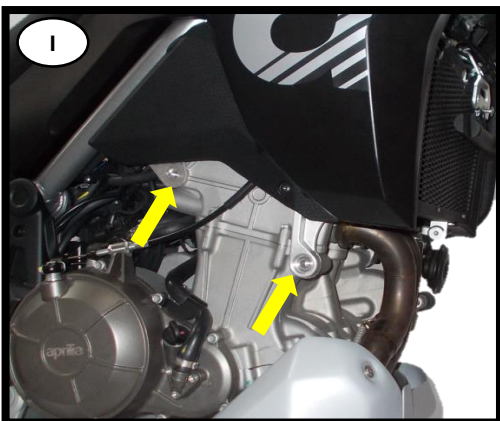

English:

- Remove original screws marked in the photo.

Français:

- Enlever les vis d'origine marquées sur la photo.

Português:

- Remover parafusos de origem marcados na foto.

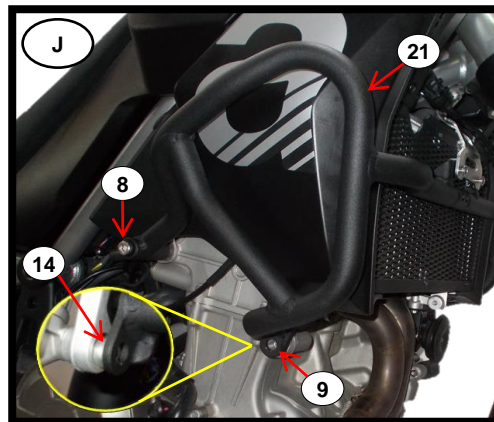

English:

- Apply item N°21 (Upper Right Crash Bar – x1) according to the photo.

Français:

- Appliquer l'item N°21 (Crash Bar Supérieur Droit – x1) conforme à la photo.

Português:

- Aplicar o item N°21 (Carenagem Superior Direita – x1) conforme a foto.

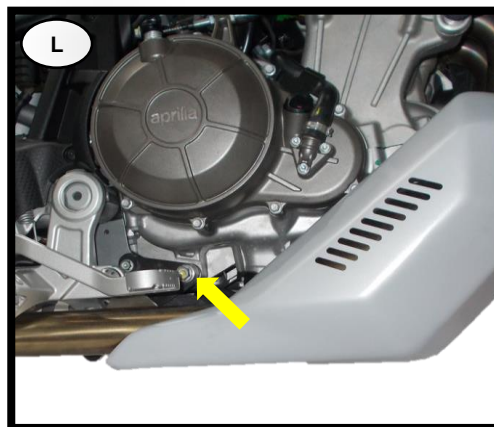

English:

- Remove original screw marked in the photo.

Français:

- Enlever le vis d'origine marqué sur la photo.

Português:

- Remover parafuso de origem marcado na foto.

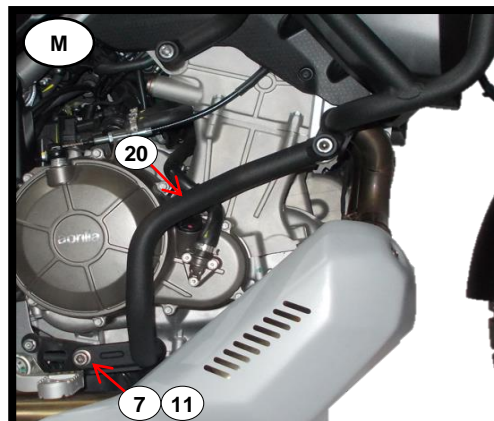

English:

- Apply item N°20 (Lower Right Crash Bar – x1) according to the photo.

Français:

- Appliquer l'item N°20 (Crash Bar Inférieur Droit – x1) conforme à la photo.

Português:

- Aplicar o item N°20 (Carenagem Inferior Direita – x1) conforme a foto.